

**PINK PROVIDES:**

- 1 Fabric
- 1 Frame
- Plastic Drop Cloth
- Gloves
- Clean & Repair Kit
- Allen Key

**YOU PROVIDE:**

- Small Tool Kit
- Site Plan/Event Layout
- Three Person Team Min.



Additional Support Please Call:  
212-253-6666 or  
After Hours: 646-853-3900

Frame is labeled for easy assembly. Simply match the corresponding parts, depress the button, and slide together.

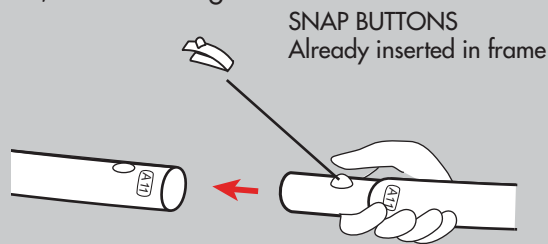

1. Join pieces to create the two arch forms and the two bases.

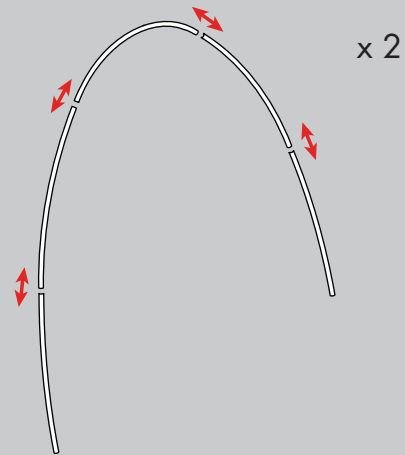

Prior to assembly, lay out drop cloth in designated work location. Before working with fabric, wash hands or put on gloves.

2. Lay one of the arches on its side. Attach the two base supports.

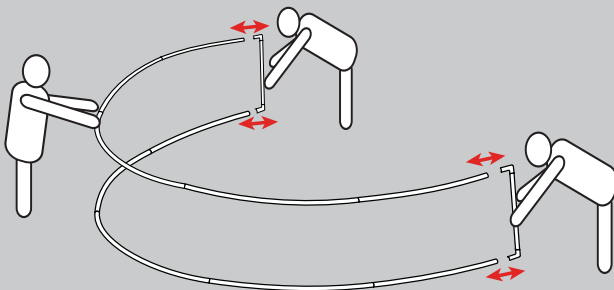

It is easiest to have one person hold the "top" arch approximately 12" from the ground.

3. Use an allen key to screw the top piece into place.

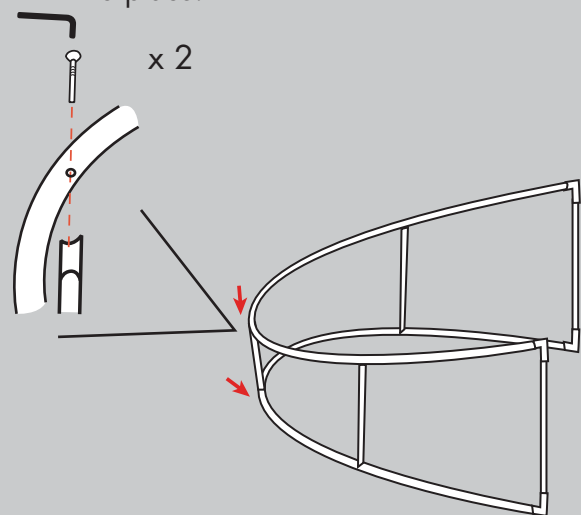

Any and all rights (including, without limitation, copyright, design patent, use patent and trademark) in and to all designs, concepts, renderings, or graphics (collectively, "Design") represented in this document were created by Moss Inc. and remain the sole and exclusive property of Moss Inc. Use of any such Design by the recipient without required purchase is strictly prohibited. ©2010

4. Stretch the fabric over the entire frame and find the zipper on the side.

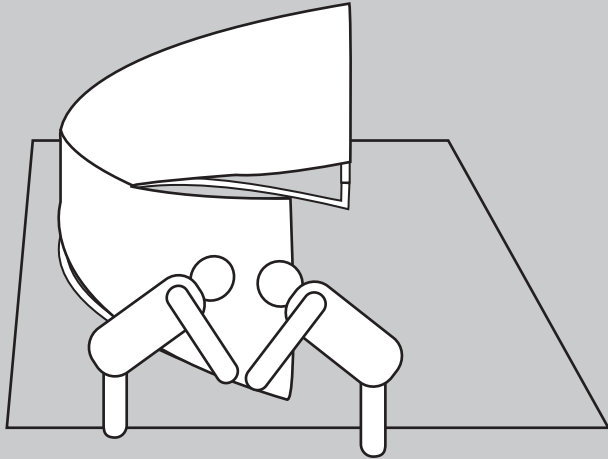

5. Have one person pull the fabric over the frame while another one zips.

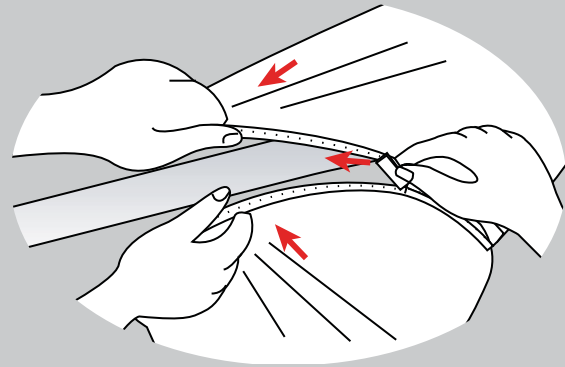

6. Stand the arch up and place the Arch in the desired location.

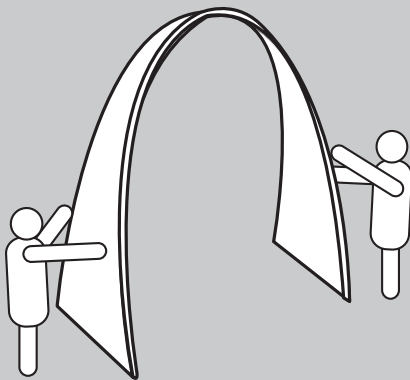

Any and all rights (including, without limitation, copyright, design patent, use patent and trademark) in and to all designs, concepts, renderings, or graphics (collectively, "Design") represented in this document were created by Moss Inc. and remain the sole and exclusive property of Moss Inc. Use of any such Design by the recipient without required purchase is strictly prohibited. ©2010